

Characteristics

Hydraulically operated directional control valves are available in 5 sizes:

- D1VP*4L NG06 – operated via end caps
- D1VP*90 NG06 – operated via end caps and mounting interface (X, Y)
- D3DP NG10 – operated via mounting interface (X, Y)
- D4P NG16 – operated via mounting interface (X, Y)
- D9P NG25 – operated via mounting interface (X, Y)
- D11P NG32 – operated via mounting interface (X, Y)

Size NG06 (D1VP) is available in two different designs:

- D1VP*4L for operating pressure >10 bar (over tank pressure) with control ports in the end caps.
- D1VP*90 for operating pressure >15 bar with control ports in the end caps and mounting interface (X, Y).

All other series are operated only via mounting interface (X, Y).

The shifting time is depending on the pilot pressure. For safe operation the minimum pilot pressure has to be ensured in all operating conditions. The maximum pilot pressure varies from the maximum operating pressure in some sizes.

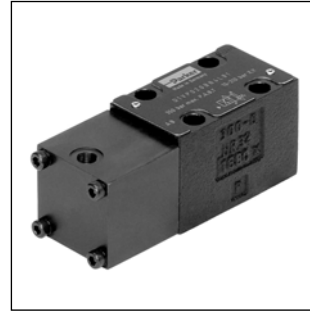

D1VP*B*4L

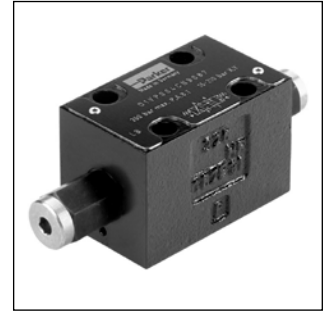

D1VP*90

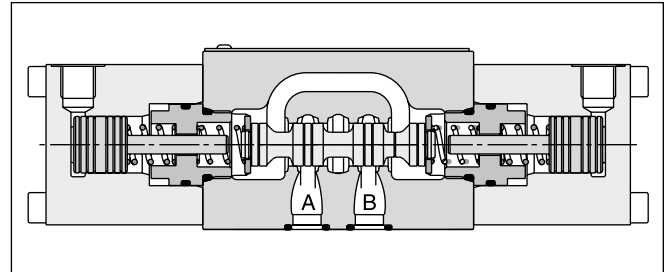

D1VP*C*4L

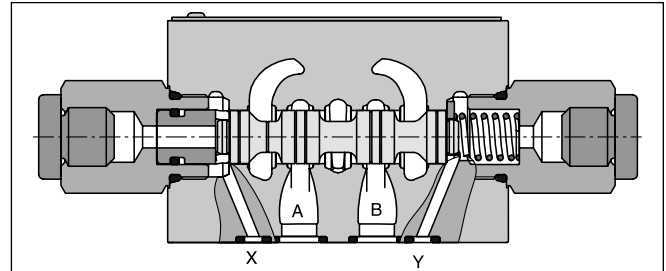

D1VP*90

Technical data

General		Directional spool valve					
Design	Hydraulic						
Actuation	Hydraulic						
Series	D1VP*4L	D1VP*90	D3DP	D4P	D9P	D11P	
Size	NG06	NG06	NG10	NG16	NG25	NG32	
Weight [kg]	1.3	1.3	3.7	9.0	17.0	66.0	
Mounting interface	DIN 24340 A06 ISO 4401 NFFPA D03	DIN 24340 A06 ISO 4401 NFFPA D03	DIN 24340 A10 ISO 4401 NFFPA D05	DIN 24340 A16 ISO 4401 NFFPA D07	DIN 24340 A25 ISO 4401 NFFPA D08	DIN 24340 A32 ISO 4401 NFFPA D10	
CETOP RP 121-H							
Mounting position	unrestricted, preferably horizontal						
Ambient temperature [°C]	-25...+60						
MTTF _p value [years]	150						
Hydraulic		P, A B, T: 350; T: 140					
Max. operating pressure [bar]	P, A B, T: 350; X, Y: 210		P, A B, T: 350; X, Y: 210		P, A B, T: 350; X, Y: 350		
Fluid	Hydraulic oil according to DIN 51524						
Fluid temperature [°C]	-20 ... +70 (NBR: -25...+70)						
Viscosity permitted [cSt] / [mm²/s]	2.8...400						
Viscosity recommended [cSt] / [mm²/s]	30...80						
Filtration	ISO 4406 (1999); 18/16/13						
Flow max. [l/min]	60 ¹⁾	60 ¹⁾	130	300	700	2000	
Leakage at 350 bar (per flow path) [ml/min]	up to 60 ²⁾	up to 60 ²⁾	up to 100 ²⁾	up to 200 ²⁾	up to 800 ²⁾	up to 5000 ²⁾	
Operating pressure (min/max) [bar]	10 ³⁾ / 210	15 / 210	15 / 210	5 / 350	5 / 350	5 / 350	
Pilot volume (start position to end position) [cm³]	0.59	0.34	1.1	4.2	12.3	59.7	
Static / Dynamic		The response times depend on the pilot oil pressure and on the speed of the increase / decrease of the pilot pressure.					
Step response							

¹⁾ Depending on spool, see shift limits.

²⁾ Depending on spool.

³⁾ > tank pressure.

2



D
 Directional control valve

1
 Size
 DIN NG06
 CETOP 03
 NFPA D03

V
 3-chamber design

P
 Hydraulically operated

Spool type

Spool position

Seals

Pilot port

Design series
 (not required for ordering)

3 position spools	
Code	Spool type
	a 0 b
001	
002	
004	
006	
008 ¹⁾	
009 ¹⁾	

2 position spools	
Code	Spool type
	a b
020	
026	
030	

Code	Pilot port
4L	High tank pressure, indirect via pilot spool
90	Direct via X, Y port or pipe thread G 1/4

Code	Seals
N	NBR
V	FPM

3 position spools ²⁾			
Code	Spool position		
C			3 positions. Spring offset in position "0". Operated in position "a" or "b".
	Standard	Spool type 008 and 009	
E			2 positions. Spring offset in position "0".
F			2 positions. Operated in position "0".
K			2 positions. Spring offset in position "0".
M			2 positions. Operated in position "0".

2 position spools ²⁾			
Code	Spool position		
B			Spring offset in position "b". Operated in position "a".
D			Detent, operated in position "a" or "b". No centre or offset position.
H			Spring offset in position "a". Operated in position "b".

¹⁾ Consider specific spool position.
²⁾ Code 4L without ports X and Y.

Further spool types and styles on request.

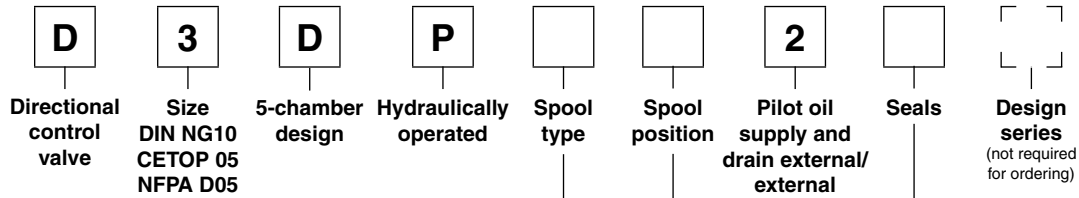

2

3 position spools	
Code	Spool type
	a 0 b
001	
002	
003	
004	
005	
006	
007	
008 ¹⁾	
009 ¹⁾	
010	
011	
014	
015	
016	
021	
022	
031	
032	
081	
082	
102	

Code	Seals
N	NBR
V	FPM

2 position spools	
Code	Spool type
	a b
020	
026	
030	
101	

3 position spools			
Code	Spool position		
C			3 positions. Spring offset in position "0". Operated in position "a" or "b".
	Standard	Spool type 008 and 009	
E			2 positions. Spring offset in position "0".
F			2 positions. Operated in position "0".
K			2 positions. Spring offset in position "0".
M			2 positions. Operated in position "0".

2 position spools			
Code	Spool position		
B			Spring offset in position "b". Operated in position "a".
D			Detent, operated in position "a" or "b". No center or offset position.
H			Spring offset in position "a". Operated in position "b".

¹⁾ Consider specific spool position.

Further spool types and styles on request.

2

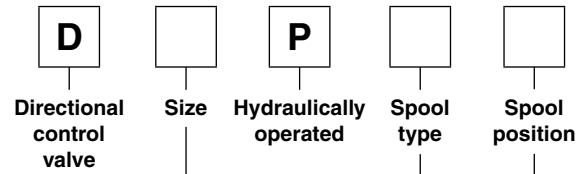

Code	Bore	Size
4	Ø20 mm	NG16
9	Ø32 mm	NG25
11	Ø50 mm	NG32

3 position spools		D4	D9	D11
Code	Spool type			
	a 0 b			
001		•	•	•
002		•	•	•
003		•	•	
004		•	•	•
005		•	•	
006		•	•	
007		•	•	
009 ¹⁾		•	•	•
011		•	•	
014		•	•	
015		•	•	
016		•	•	
021		•	•	
022		•	•	
031			•	
032			•	
054		•	•	•
081		•	•	•
082		•	•	•

2 position spools		D4	D9	D11
Code	Spool type			
	a b			
020		•	•	•
026		•	•	
030		•	•	•

3 position spools		
Code	Spool position	
C		3 positions. Spring offset in position "0". Operated in position "a" or "b".
	Standard	Spool type 009
E		2 positions. Spring offset in position "0".
	Operated in position "a".	Operated in position "b".
F		2 positions. Operated in position "0".
	Spring offset in position "b".	Spring offset in position "a".
K		2 positions. Spring offset in position "0".
	Operated in position "b".	Operated in position "a".
M		2 positions. Operated in position "0".
	Spring offset in position "a".	Spring offset in position "b".
R ²⁾		2 positions detent. Operated in position "0" or "b".
	No centre in offset position.	No centre in offset position.
S ²⁾		2 positions detent. Operated in position "0" or "a". No center in offset position.
	No centre in offset position.	No centre in offset position.

2 position spools		
Code	Spool position	
B		Spring offset in position "b". Operated in position "a".
D		Detent, operated in position "a" or "b". No centre or offset position.
H		Spring offset in position "a". Operated in position "b".

¹⁾ Consider specific spool position.
²⁾ Only D4 and D9 available.

Ordering Code

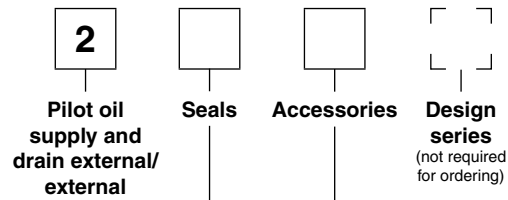

Code	Accessories
omit	Standard valve w/o accessories
3A	Pilot choke, meter-out
3B	Pilot choke, meter-in
3D ²⁾	Stroke adjustment side B
3E ²⁾	Stroke adjustment side A
3F ²⁾	Stroke adjustment side A and B

Code	Seals
N	NBR
V	FPM

2

Further spool types, styles and position control on request.

Flow Curve Diagrams / Shift Limits

The flow curve diagram shows the flow versus pressure drop curves for all spool types. The relevant curve number

for each spool type, operating position and flow direction is given in the table below.

Spool	Position „b“		Position „a“		Position „0“				
	P->A	B->T	P->B	A->T	P->A	P->B	A->T	B->T	P->T
001	2	2	2	2	-	-	-	-	-
002	1	4	1	4	1	1	5	5	2
004	2	3	2	3	-	-	7	7	-
006	1	4	1	4	7	7	-	-	-
020	4	4	2	3	-	-	-	-	-
026	4	-	4	-	-	-	-	-	-
030	2	3	1	2	-	-	-	-	-
	P->B	A->T	P->A	B->T	P->A	P->B	A->T	B->T	P->T
008	4	5	4	5	-	-	-	-	8
009	5	5	6	7	-	-	-	-	7

Flow curves

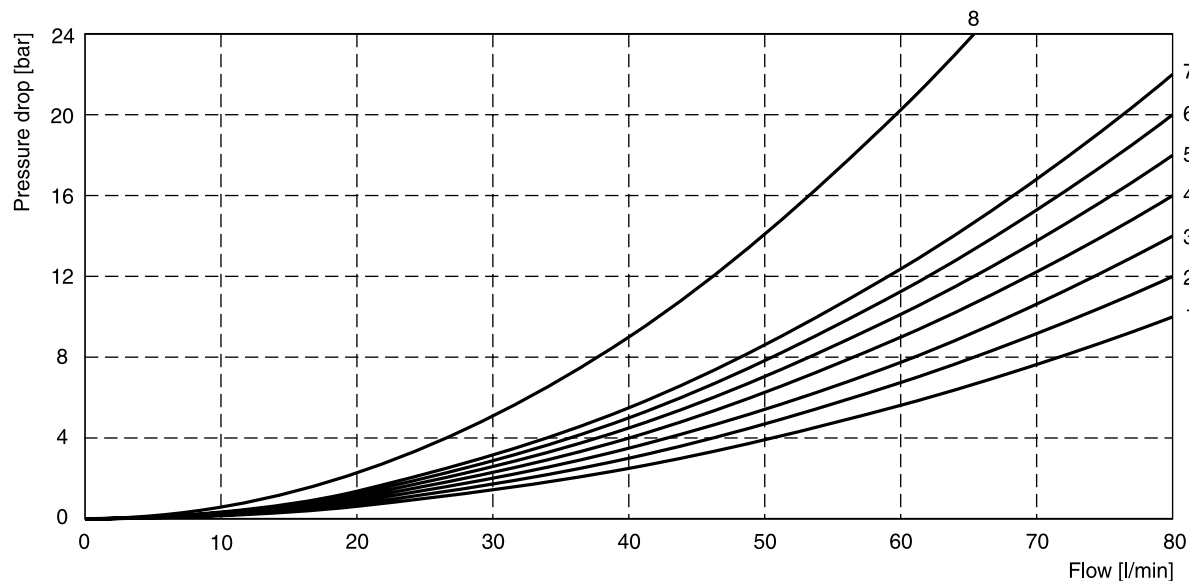

All characteristic curves measured with HLP46 at 50°C.

Shift limits

Spool	Shift limit [l/min]
001	60
002	
004	
006	
020	
030	
008	40
009	
026	20

The flow curve diagram shows the flow versus pressure drop curves for all spool types. The relevant curve number for each spool type, operating position and flow direction is given in the table below.

Spool	Position „b“		Position „a“		Position „0“						
	P-A	B-T	P-B	A-T	P-A	P-B	A-T	B-T	P-T	A-B	
001	4	3	4	3	–	–	–	–	–	–	
002	2	4	3	3	2	2	1	2	3	4	
003	2	2	4	1	–	–	5	–	–	–	
004	4	3	3	2	–	–	5	5	–	6	
005	1	3	4	2	4	–	–	–	–	–	
006	2	4	3	3	5	5	–	–	–	6	
007	4	2	2	2	–	2	–	2	5	–	
010	2	–	2	–	–	–	–	–	–	–	
011	3	3	2	3	–	–	10	10	–	11	
014	2	3	4	2	2	–	2	–	5	–	
015	4	2	2	2	–	–	–	4	–	–	
016	4	2	1	1	–	4	–	–	–	–	
020	4	4	4	4	–	–	–	–	–	–	
026	3	–	3	–	–	–	–	–	–	–	
030	4	3	3	3	–	–	–	–	–	–	
081	6	7	6	7	–	–	–	–	–	–	
082	7	7	6	5	–	–	11	11	–	11	
101	9	9	9	9	–	–	–	–	–	–	
102	2	2	2	1	6	6	3	5	6	6	
	P-B	A-T	P-A	B-T	P-A	P-B	A-T	B-T	P-T	A-B	
008	4	2	5	6					8		
009	2	5	2	6	–	–	–	–	8	–	
	Position „b“		Position „a“		Position „0“						
	P-A	B-T	A-B	P-B	A-T		A-T				
021	3	5	6	4	2	–	–	–			
031	3	5	6	4	1	–	9	–			
	P-A	B-T		P-A	P-B	A-B		B-T			
022	5	4	–	5	2	6	–	–			
032	5	2	–	5	2	6	–	9			

2

Flow curves

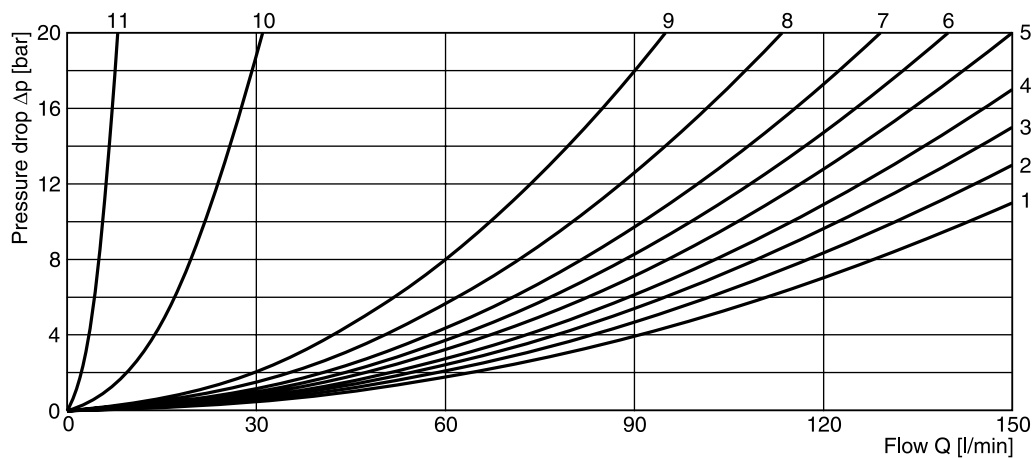

All characteristic curves measured with HLP46 at 50°C.

The flow curve diagram shows the flow versus pressure drop curves for all spool types. The relevant curve number

for each spool type, operating position and flow direction is given in the table below.

D4P

Spool Code	Curve number				
	P-A	P-B	P-T	A-T	B-T
001	1	1	-	4	5
002	1	2	6	4	6
003	1	2	-	5	6
004	1	1	-	5	5
005	2	2	-	3	5
006	1	2	-	3	6
007	1	1	6	4	5
009	2	9	8	7	10
011	1	1	-	4	5
014	1	1	6	4	5
015	1	2	-	4	6
016	2	2	-	3	5
020	3	5	-	3	5
021	2	8	-	2	-
022	8	2	-	-	3
026	3	5	-	-	-
030	2	3	-	6	7
054	2	3	-	6	7

D4P

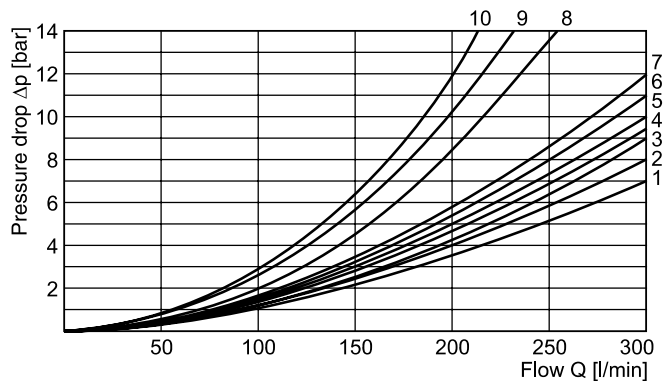

D9P and D11P

Spool Code	Curve number									
	P-A		P-B		P-T		A-T		B-T	
	D9	D11	D9	D11	D9	D11	D9	D11	D9	D11
001	3	5	2	5	-	-	3	4	5	1
002	2	5	1	5	1	5	3	4	5	1
003	4	-	2	-	-	-	3	-	6	-
004	4	5	3	5	-	-	3	4	5	1
005	1	-	2	-	-	-	4	-	5	-
006	2	-	2	-	-	-	4	-	6	-
007	3	-	1	-	7	-	3	-	5	-
009	4	3	8	3	9	2	4	3	10	1
011	3	-	2	-	-	-	3	-	5	-
014	1	-	2	-	8	-	3	-	5	-
015	3	-	3	-	-	-	4	-	5	-
016	3	-	3	-	-	-	4	-	5	-
020	6	5	5	5	-	-	6	3	8	1
021	5	-	10	-	-	-	3	-	-	-
022	10	-	5	-	-	-	-	-	5	-
026	6	-	5	-	-	-	-	-	-	-
030	3	5	2	5	-	-	3	4	5	1
054	-	5	-	5	-	-	-	4	-	1

D9P

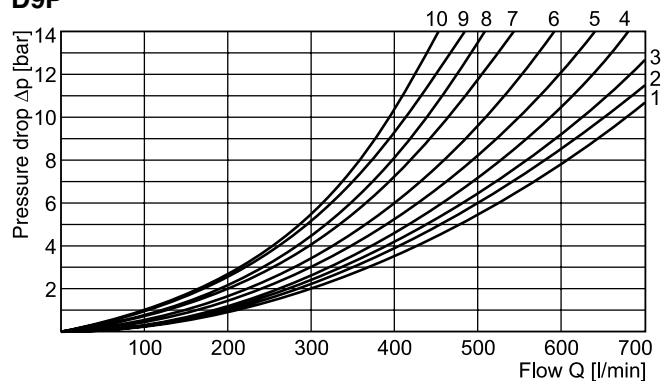



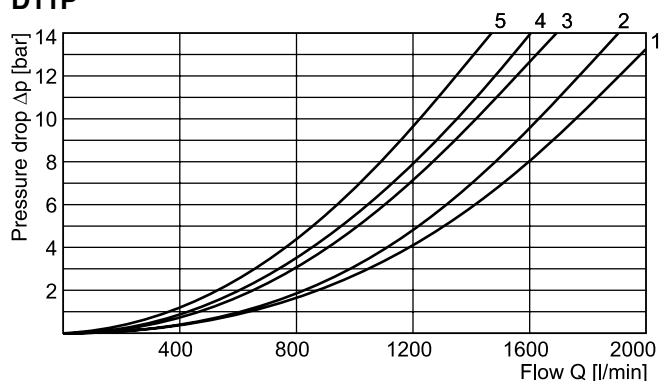



D11P

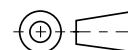
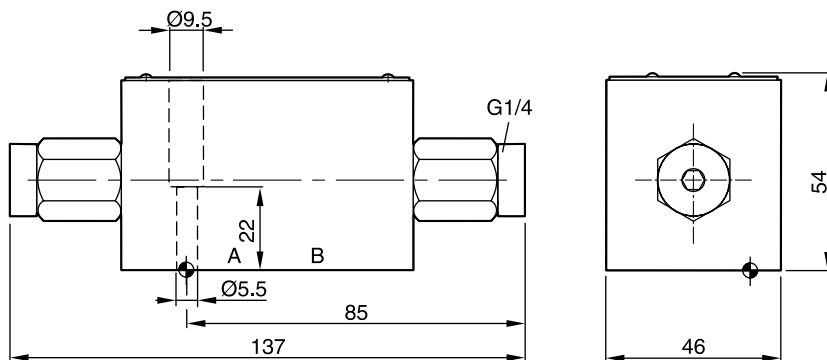

All characteristic curves measured with HLP46 at 50°C.





D1VP*90

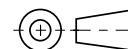
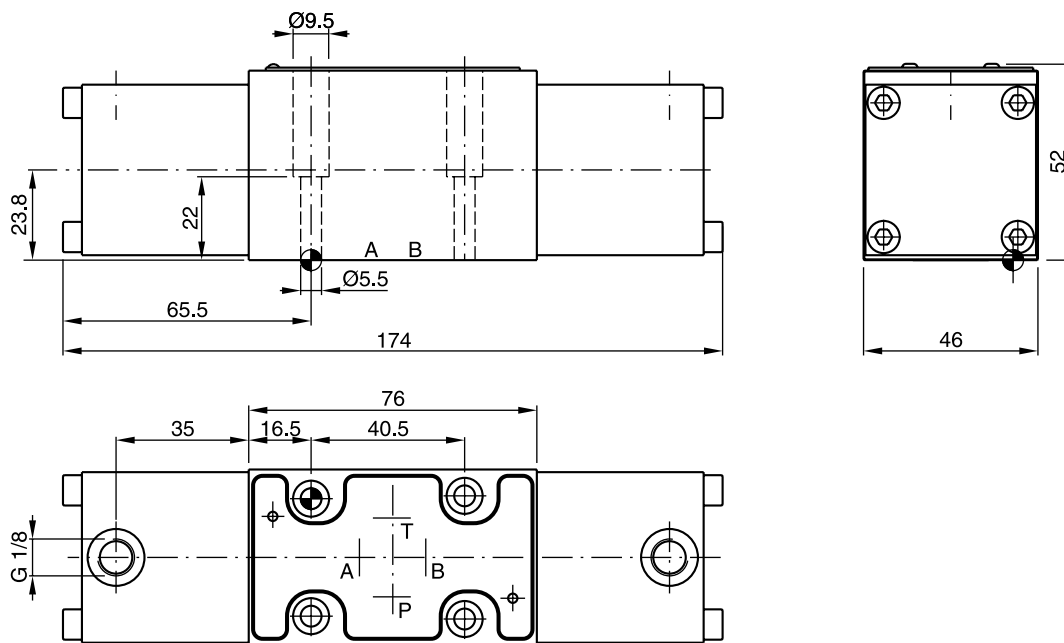

Surface finish	 Kit			 Kit
$\sqrt{R_{max} 6.3}$ 	BK375	4x M5x30 ISO 4762-12.9	7.6 Nm ±15 %	NBR: SK-D1VP-N-87 FPM: SK-D1VP-V-87

D1VP*4L





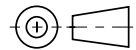
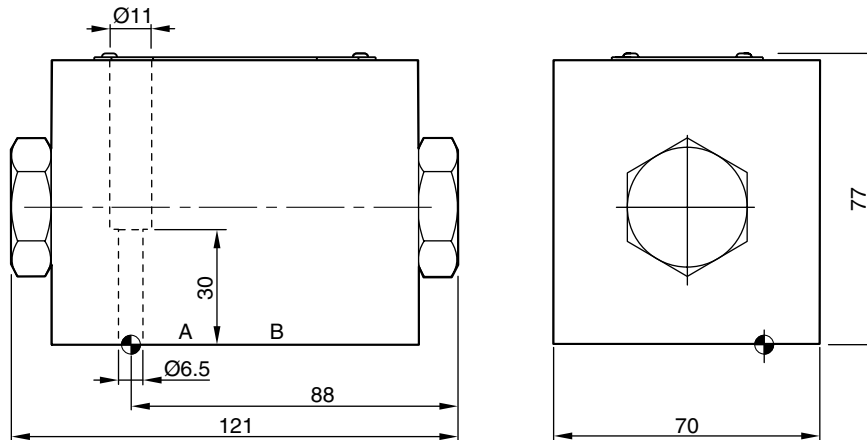

Surface finish	 Kit			 Kit
$\sqrt{R_{max} 6.3}$ 	BK375	4x M5x30 ISO 4762-12.9	7.6 Nm ±15 %	NBR: SK-D1VP-N4-91 FPM: SK-D1VP-V4-91

D3DP



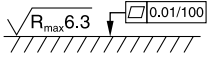

2

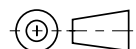
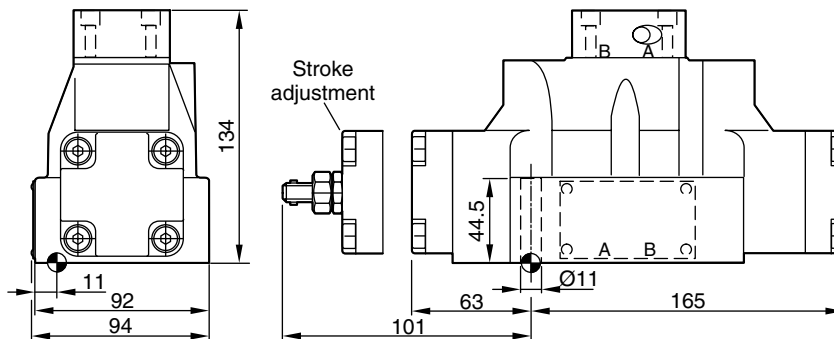

Surface finish	 Kit	 Kit	 Kit	 Kit
	BK385	4x M6x40 ISO 4762-12.9	13.2 Nm ±15 %	NBR: SK-D3DP-N-42 FPM: SK-D3DP-V-42

D4P

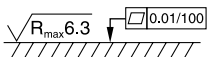

Surface finish	 Kit	 Kit	 Kit	 Kit
	BK320	4x M10x60 2 x M6x55 ISO 4762-12.9	63 Nm ±15 % 13.2 Nm ±15 %	NBR: SK-D41VW-N-91 FPM: SK-D41VW-V-91

D9P

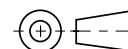
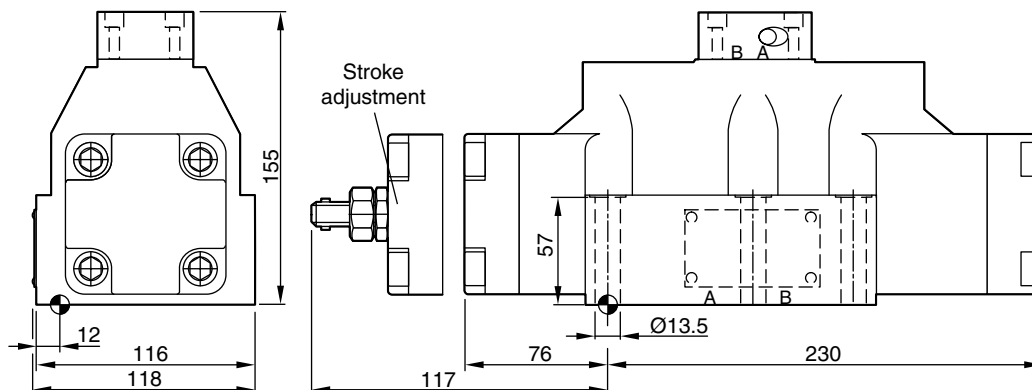

Surface finish	Kit	Kit	Kit	Kit
$\sqrt{R_{max} 6.3}$	BK360	6x M12x75 ISO 4762-12.9	108 Nm ±15 %	NBR: SK-D91VW-N-91 FPM: SK-D91VW-V-91

D11P

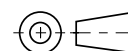
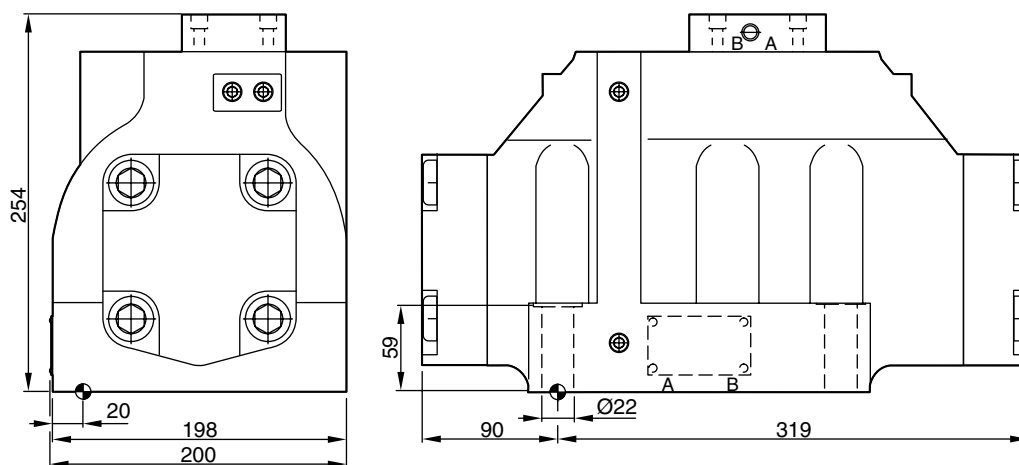

Surface finish	Kit	Kit	Kit	Kit
$\sqrt{R_{max} 6.3}$	BK386	6x M20x90 ISO 4762-12.9	517 Nm ±15 %	NBR: SK-D111VW-N-91 FPM: SK-D111VW-V-91