

**P1E Rod Guidance Module**

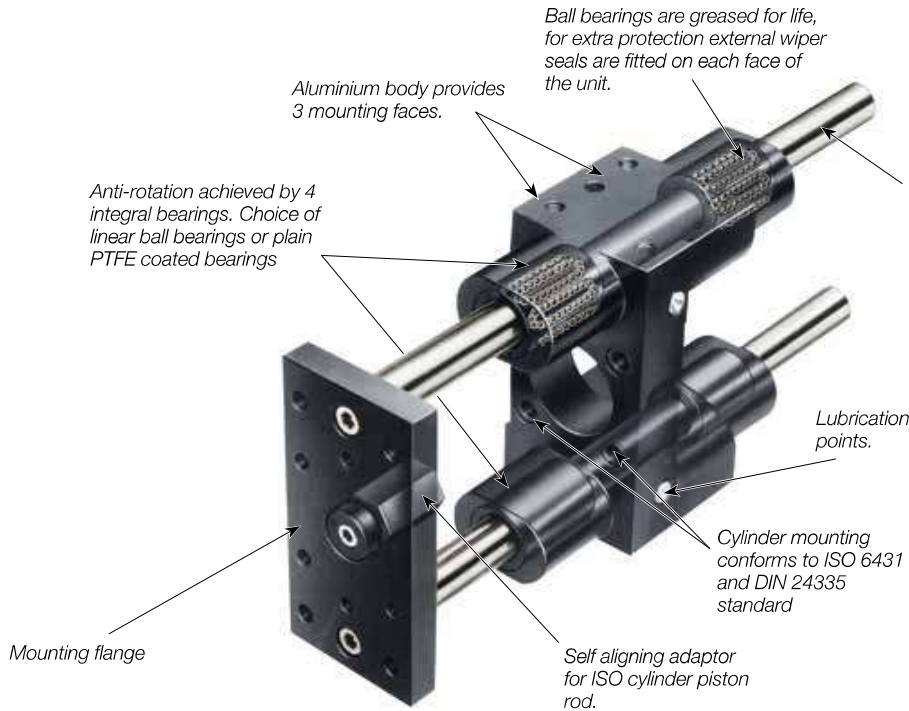

Guide bars:  
Ball bearing versions stainless steel.  
Plain bearing version hard chrome plated.

**Installation on P1D-L with lock unit**

If rotary control is to be retrofitted to a P1D-L with lock unit, the piston rod must be extended to provide the same WH dimensions as for the P1D base cylinder, as shown in the table below.

Cyl. dim mm	Piston rod extension on P1D-L with lock unit mm
32	11
40	14
50	20
63	20
80	26
100	31

**P1E with rod guidance modules**

The P1D series cylinders can be equipped with an external guiding device to prevent the piston rod from turning. The factory fitted guide gives a guided piston movement and enables the cylinder to take up turning moments on the piston rod, as well as greater transverse forces. The rod guidance is available with plain bearings or linear ball bearings and with H or U style. The bracket, which has pre-drilled mounting holes, is connected to the piston rod by means of a flexo coupling, which prevents the build-up of stresses in the cylinder. P1D cylinders with guiding devices are available with bores from 32 to 100 mm, and standard stroke lengths from 25 to 250 mm. Special stroke lengths up to 500 mm can also be obtained. Separate guiding device kits can be supplied on request according to the order key below.

**Technical data**

Working temperature -20 °C to +80 °C

**Material specifications, guidance modules**

Body	Anodised aluminium
Guide bars, H style	Stainless steel for ball bearing chrome plated for plain bearing
Front plate	Anodised aluminium
Guide bars, U style	Stainless steel
Front plate	Zinc-plated steel
Bearings	Plain bearings Linear ball bearings

**Order key for separate guidance module**

**P1E - 4KRH - 0100**

Bore size mm	Guide module type	Stroke length (mm)
<b>K</b> 32	<b>H</b> H style, ball bearings	Same as for the cylinder e.g. <b>0100</b> = 100 mm.
<b>L</b> 40	<b>J</b> H style, plain bearings	
<b>M</b> 50	<b>K</b> U style, plain bearings	
<b>N</b> 63		
<b>P</b> 80		
<b>Q</b> 100		

Technical information 'H style'

Rod guide with ball bearings

Maximum load carried

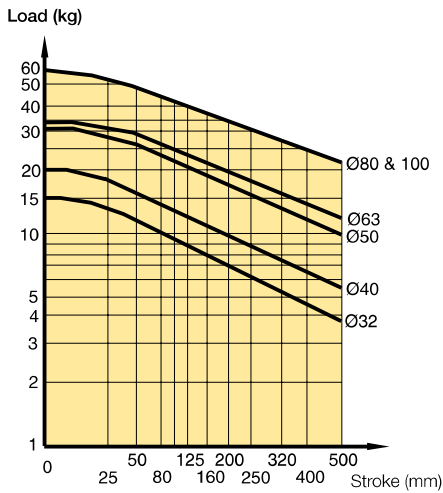

Rod guide with plain bearings

Maximum load carried

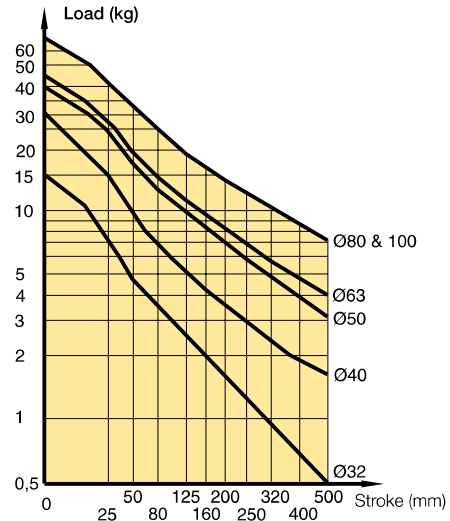

Maximum deflection/max load

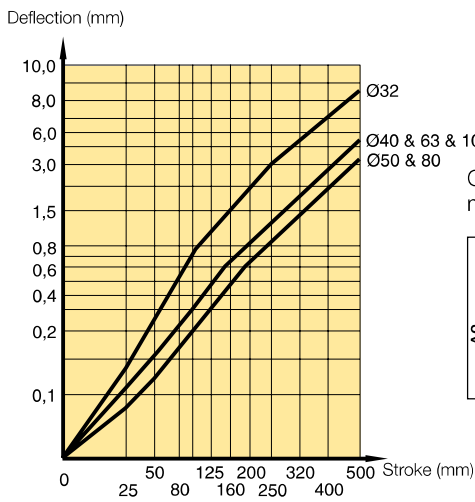

Maximum deflection/max load

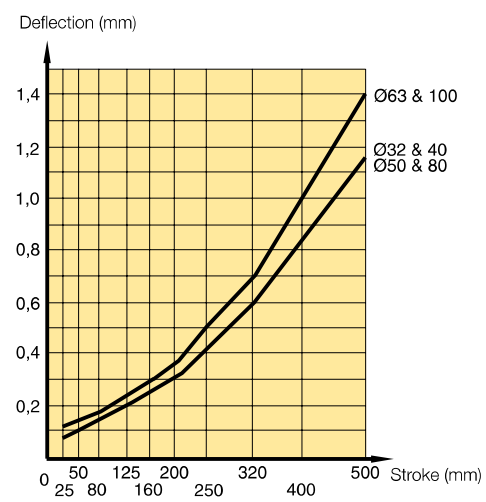

Maximum permissible torque (Nm)

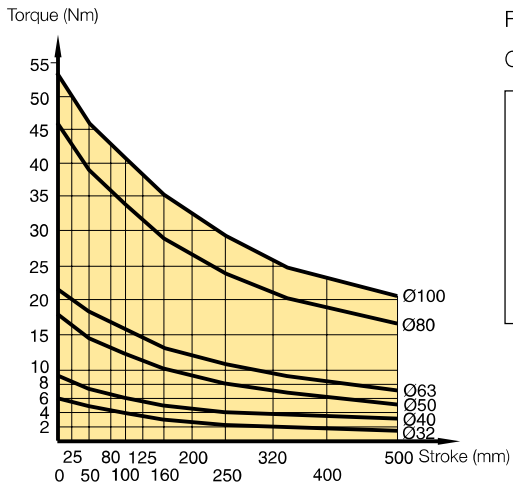

Formula:

$$C(Nm) = F(N) \times L(m)$$

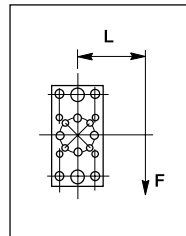

Maximum permissible torque (Nm)

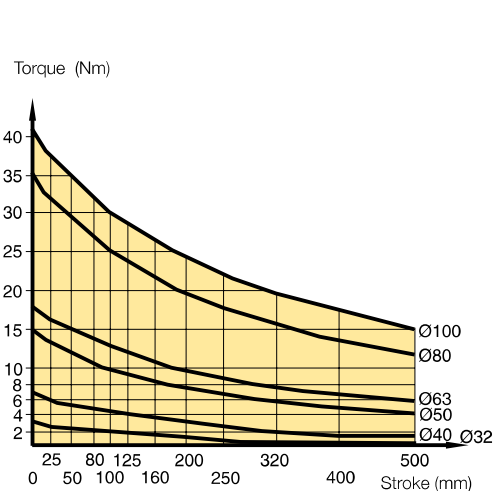

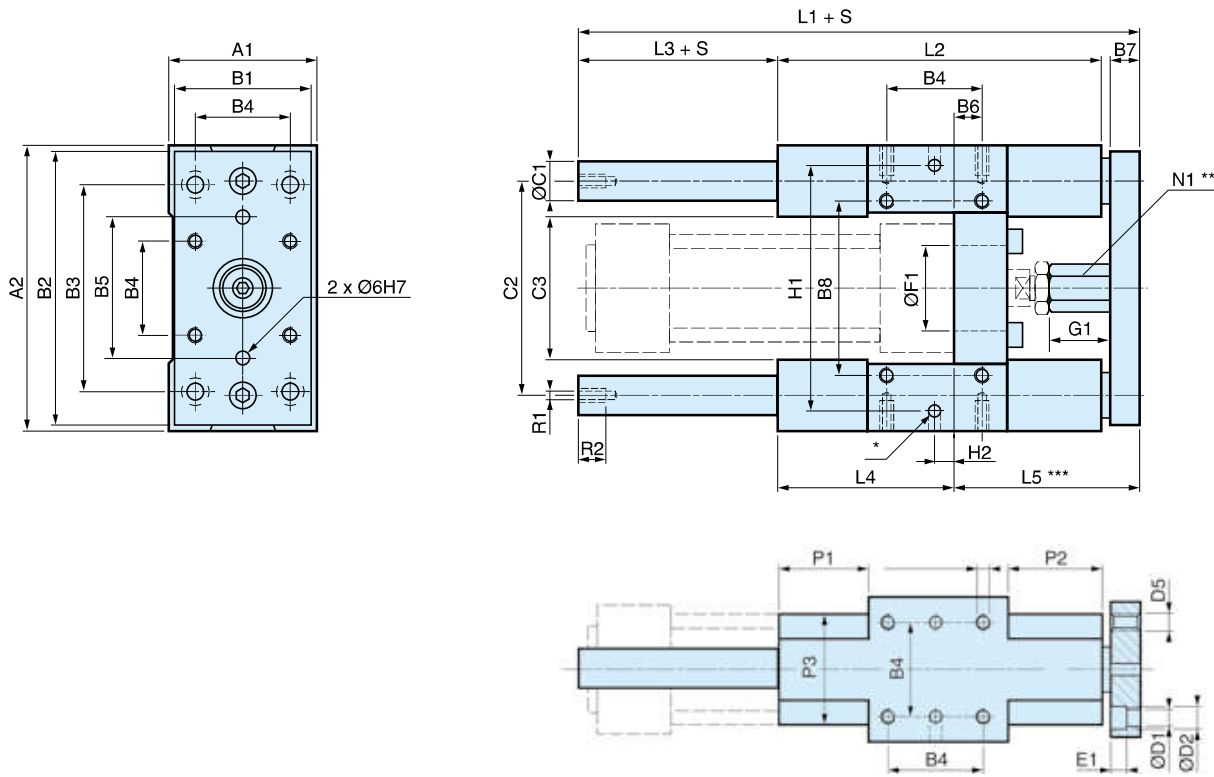

**Dimensions, H style guidance modules**

Cyl. bore mm	A <sub>1</sub> mm	A <sub>2</sub> mm	B <sub>1</sub> mm	B <sub>2</sub> mm	B <sub>3</sub> mm	B <sub>4</sub> mm	B <sub>5</sub> mm	B <sub>6</sub> mm	B <sub>7</sub> mm	B <sub>8</sub> mm	ØC <sub>1</sub> mm	C <sub>2</sub> mm	C <sub>3</sub> mm	ØD <sub>1</sub> mm	ØD <sub>2</sub> mm	D <sub>5</sub>
32	50	97	45	90	78	32,5	50	4,2	12	61	12	73,5	50	6,6	11	M6
40	58	115	54	110	84	38,0	54	11,0	12	69	16	86,5	58	6,6	11	M6
50	70	137	63	130	100	46,5	72	18,8	15	85	20	103,5	70	8,4	15	M8
63	85	152	80	145	105	56,5	82	15,0	15	100	20	118,5	83	8,4	15	M8
80	105	189	100	180	130	72,0	106	21,0	20	130	25	147,0	102	10,5	18	M10
100	130	213	120	200	150	89,0	131	24,5	20	150	25	171,5	125	10,5	18	M10

Cyl. bore mm	E <sub>1</sub> mm	Ø F <sub>1</sub> <sup>+0,1/0</sup> G <sub>1</sub> mm	L <sub>1</sub> mm	L <sub>2</sub> mm	L <sub>3</sub> mm	L <sub>4</sub> mm	L <sub>5</sub> mm	N <sub>1</sub> mm	P <sub>1</sub> <sup>+1</sup> mm	P <sub>2</sub> <sup>+1</sup> mm	P <sub>3</sub> mm	R <sub>1</sub> mm	R <sub>2</sub> mm	W mm	mm
32	7	30	17	150	120	15	71	64	17	36	31	40	M6	11	5
40	7	35	24	170	130	25	71	74	17	36	36	44	M6	11	6
50	9	40	27	197	150	24	79	89	24	42	44	50	M8	16	8
63	9	45	27	222	180	24	109	89	24	58	44	60	M8	16	8
80	11	45	32	247	200	24	113	110	30	50	52	70	M10	16	10
100	11	55	32	267	220	24	128	115	30	49	51	70	M10	16	10

Cyl. bore mm	H <sub>1</sub> <sup>+0,05</sup> mm	H <sub>2</sub> mm	T mm	Weight at 0 mm stroke kg	Supplement weight per 10 mm stroke kg
32	81	11,7	12	0,970	0,018
40	99	8,0	12	1,550	0,032
50	119	4,2	16	2,560	0,050
63	132	13,0	16	3,570	0,050
80	166	15,0	20	6,530	0,078
100	190	20,5	20	8,760	0,078

S = Stroke length

\* 6 hole Ø6 H7, depth 10<sup>+1/0</sup>

\*\* Hexagon profile

\*\*\* Min adjustment=0, max.=W

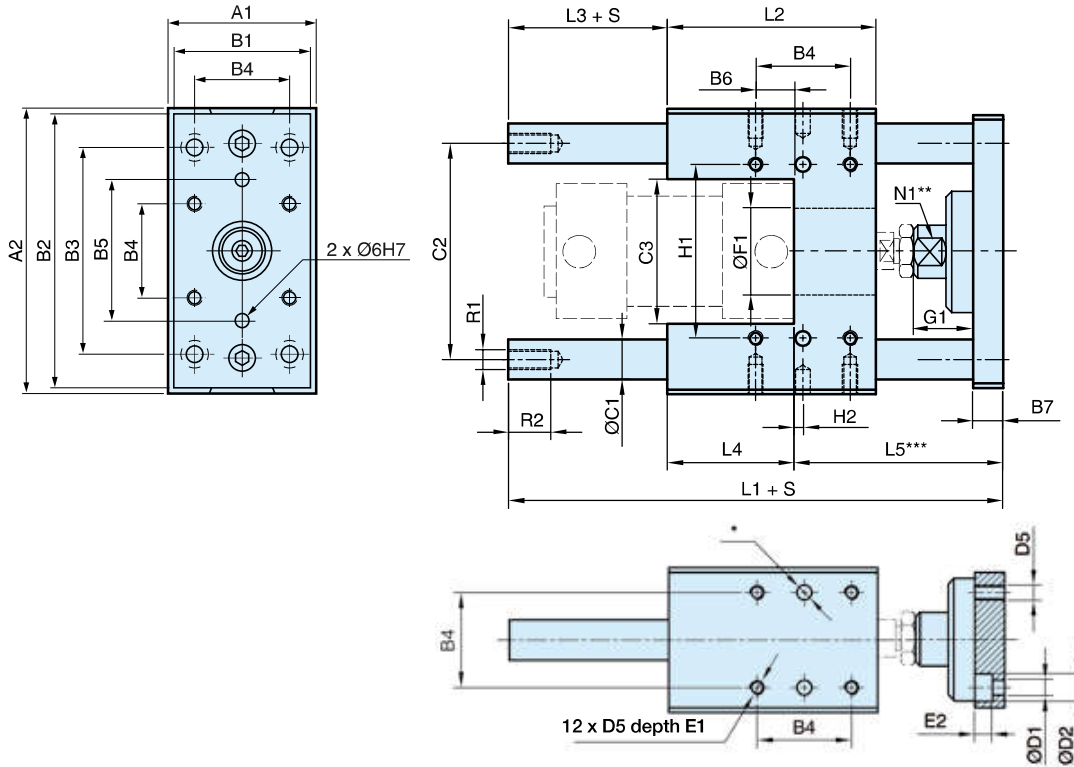

**Dimensions, U style guidance modules**

Cyl. bore. mm	A <sub>1</sub> mm	A <sub>2</sub> mm	B <sub>1</sub> mm	B <sub>2</sub> mm	B <sub>3</sub> mm	B <sub>4</sub> mm	B <sub>5</sub> mm	B <sub>6</sub> mm	B <sub>7</sub> mm	C <sub>1</sub> mm	C <sub>2</sub> mm	C <sub>3</sub> mm	D <sub>1</sub> mm	D <sub>2</sub> mm	D <sub>5</sub>
32	50	97	45	90	78	32,5	50	18,0	12	12	74	50	6,6	11	M6
40	58	115	54	110	84	38,0	54	15,5	12	16	87	58	6,6	11	M6
50	70	137	63	130	100	46,5	72	19,5	15	20	104	70	9,0	15	M8
63	85	152	80	145	105	56,5	82	29,5	15	20	119	85	9,0	15	M8
80	105	189	100	180	130	72,0	106	39,0	20	25	148	105	11,0	18	M10
100	130	213	120	200	150	89,0	131	53,5	20	25	172	130	11,0	18	M10

Cyl. bore. mm	E <sub>1</sub> mm	E <sub>2</sub> mm	Ø F <sub>1</sub> <sup>+0,1/0</sup> mm	G <sub>1</sub>	L <sub>1</sub> mm	L <sub>2</sub> mm	L <sub>3</sub> mm	L <sub>4</sub> mm	L <sub>5</sub> mm	N <sub>1</sub> mm	R <sub>1</sub> mm	R <sub>2</sub>	H <sub>1</sub> <sup>+0,05</sup> mm	H <sub>2</sub> mm	W <sup>***</sup> mm
32	10	6,5	30	30	133	72	14	44	75	13	M6	11	61	1,75	5
40	10	6,5	35	36	149	84	12	51	86	15	M8	12	69	3,50	5
50	13	9,0	40	42	175	100	12	60	103	22	M8	12	85	3,75	5
63	13	9,0	45	42	190	115	12	75	103	22	M8	12	100	1,25	5
80	16	11,0	45	49	238	162	0	112	126	27	M10	16	130	3,00	6
100	16	11,0	55	49	249	167	6	112	131	27	M10	16	150	8,50	6

Cyl. bore mm	Weight at 0 mm stroke kg	Supplement weight per 10 mm stroke kg
32	0,970	0,018
40	1,550	0,315
50	2,560	0,493
63	3,570	0,493
80	6,530	0,770
100	8,760	0,770

S = Stroke length

\* 6 hole Ø6 H7, depth 10<sup>+1/0</sup>

\*\* Width of jaw

\*\*\* Min adjustment=0, max.=W